



Shenzhen Coincell Battery Co., Ltd.

深圳市科恩瑟尔电池有限公司

Lithium-manganese dioxide Primary Button Battery—一次锂锰纽扣电池

# Product Specification

## 产品规格承认书

Customer Code客户代码: \_\_\_\_\_

Customer Product Model客户产品型号: \_\_\_\_\_

Coincell Battery cell Model.科恩瑟尔电芯型号: **CR3032**

Coincell Battery Product Model. 科恩瑟尔电池型号: \_\_\_\_\_

Battery Capacity 产品容量: **3.0V 500mAh**

Document Number 文件号: \_\_\_\_\_

Prepared by制作人	Checked by审核人	Approved by批准人
仪燕会	Xu Jie Kang	Xia Qing

Customer Approval 客户承认	Customer Signature/Date 客户签名/日期	Customer Company Stamp 客户公司盖章

深圳市科恩瑟尔电池有限公司

地址: 中国广东省深圳市龙华区

大浪街道华荣路龙兴商业大厦5008

Shenzhen Coincell Battery Co., Ltd.

Address: 5008 Longxing commercial building, Huarong Road, Dalang Street Longhua District,

Shenzhen City, Guangdong Province, China



# Lithium Manganese Dioxide Battery

## Model CR3032

### Specifications

Nominal Discharge current	0.4mA
Nominal Voltage	3V
Nominal Capacity	500(mAh)
Continuous standard load	7.5(kΩ)
Maximum pulse current	30mA
Operating temperature	-20°C~70°C
Weight	6.8 (g)

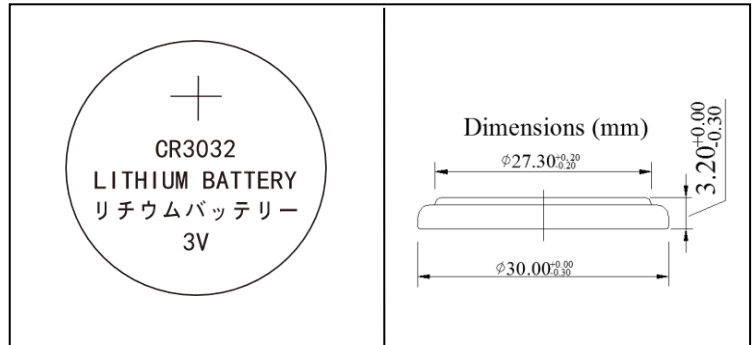

### Characteristics

**Discharge Characteristics**

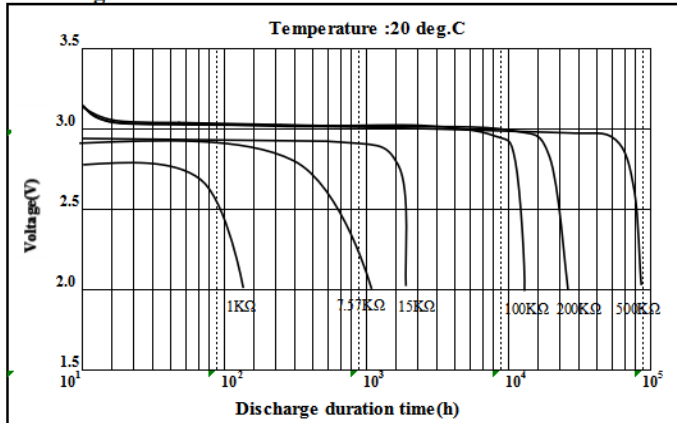

**Discharge Characteristics**

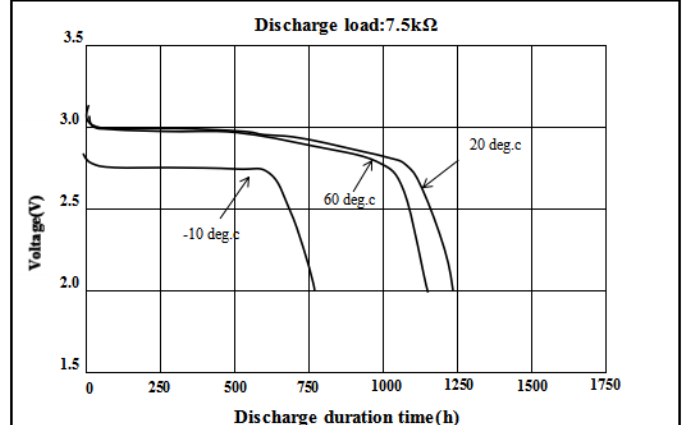

**Pulse Discharge Characteristics**

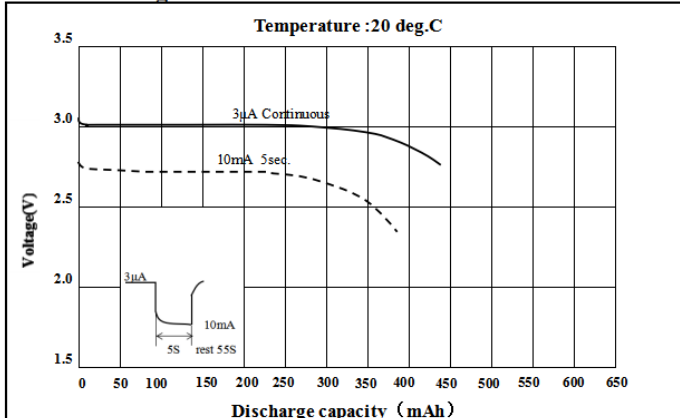

**Relationship between Discharge Current and Discharge Capacity**

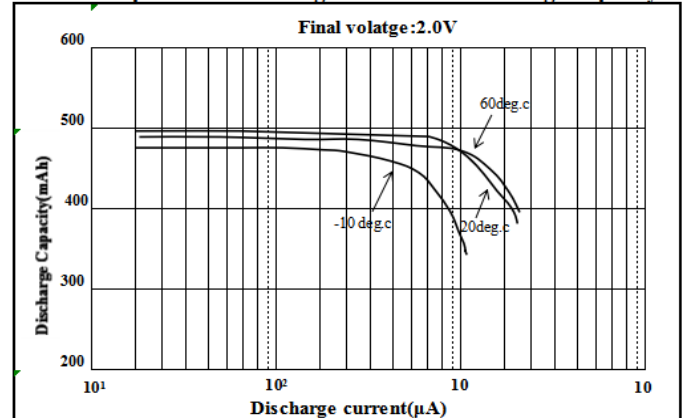

<WARNING>

- (1)Never charge the battery. Charging the battery may cause seethe of the battery electrolyte or increase of the battery internal pressure. Leakage, heating, explosion or ignition of the battery may be caused as a result of it.
- (2)Keep away from infants. If infant happens to swallow the battery, consult a doctor Immediately
- (3)Note: if the temperature is higher than the continuous use + 60 °C or below -10°C. Please contact us.

Date of issue: Nov 2020

**■ Characteristics :****[ TABLE 1 ]**

TEST ITEMS	TEMPERATURE	INITIAL	AFTER 12 MONTHS	REMARKS
Open-circuit Voltage	20±2°C	3.0V TO 3.4V	3.0V TO 3.4V	
Closed-circuit Voltage	20±2°C	3.0V TO 3.4V	3.0V TO 3.4V	Standard Load Resistance . 0.8 Sec.

**[ TABLE 2 ]**

TEST ITEMS	TEMPERATURE	INITIAL	AFTER 12 MONTHS	REMARKS
Service Life	20±2°C	See graph for details	≥ 98% of initial capacity	Continuous Discharge Under Standard Load to 2.0V End-Voltage

**[ TABLE 3 ]**

TEST ITEM	STORAGE TEMP	STORAGE PERIOD	REQUIREMENT	REMARKS
Service Life After Storage At High Temperature	60 ±2°C	20 Days	≥ 98% of initial capacity	Continuous Discharge At 20±2°C Under Standard Load To 2.0V End-Voltage After Storage.

**[ TABLE 4 ]**

TEST ITEM	REQUIREMENT	TEST CONDITIONS
Leakage Characteristics	No Leakage	Temperature: 45 ± 2°C, Relative Humidity: 75% Storage: 30 Days Shall Be Inspected By Visual Means

**[ TABLE 5 ]**

TEST ITEM	REQUIREMENT	TEST CONDITIONS
Self-discharge	2% or Below	Continuous Discharge Under Standard Load To 2.0V End-voltage After 12 Months Storage At 20°C. ( To Obtain From The Mean Value Of The Same Lot )

■ **Markings:**

Markings on batteries :

- 5.1.1 Battery type : CR3032
- 5.1.2 Brand of battery:
- 5.1.3 Polarity : + [(-) shall not be indicated]
- 5.1.4 Manufacturing marks : The year and month of production shall be marked on the negative (-) terminal side

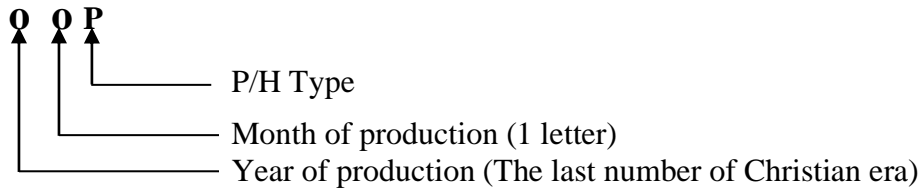

- [Example] 01P P/H type Manufactured in January 2020
- 0XP P/H type Manufactured in October 2020
- 0YP P/H type Manufactured in November 2020
- 0ZP P/H type Manufactured in December 2020

Month of production.

- January to September -- 1- 9
- Oct, Nov, Dec, -----X, Y, Z

■ **Precautions in Designing a Memory Backup Circuit**

A primary lithium battery is not rechargeable. When used for memory backup in combination with another power source, current may flow into the battery from the other source. To prevent this, include a protection diode and resistor in the circuit so that no battery charging or over discharging can occur. Allowable Range of Diode Back-Leakage Current. To prevent the battery from being charged by the main power source, be sure to use a back-current prevention diode and a protection resistor. Select a silicon diode or a Schottky diode with minimum leakage current, and design the circuit so that the amount of charging due to leakage current does not exceed 1% of the nominal battery capacity over the total period of use.

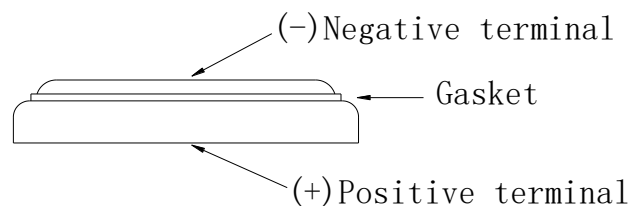
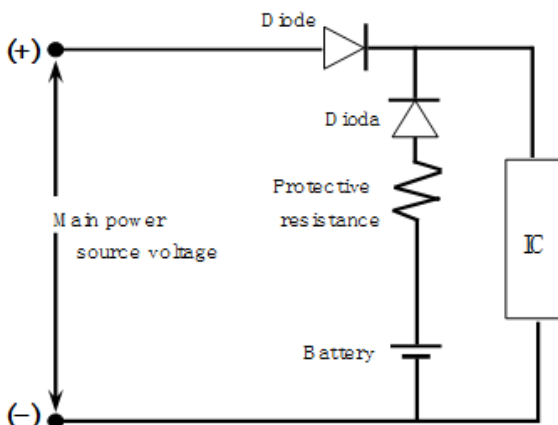

**Maximum Allowable Charge Current to Battery**

Model	Maximum allowable charging current	Model	Maximum allowable charging current	Maximum allowable charging voltage
CR1620	10mA	CR2430	10mA	5V
CR1632	10mA	CR2450	15mA	
CR2016	10mA	CR2477	15mA	
CR2025	10mA	CR3032	15mA	
CR2032	10mA	CR3832	15mA	
CR2050	10mA			

Protection resistance R must exceed the value calculated in the following formula:

$$R \geq \frac{V (\text{Main power source voltage})}{I (\text{Maximum allowable charge current per battery})}$$

**Precautions for Mounting****1. Overlapping Batteries**

Lithium Manganese Dioxide Battery is shaped as shown below. It has exposed positive(+)and negative(-) metallic surfaces with a thin cylindrical seal, called the gasket, inbetween them. When the batteries are overlapped or mixed together in a disorderly way, their positive(+)and negative(-)terminals touch each other, causing short-circuits.

**2. The Batteries Put in a Metallic Container or on a Metallic Plate**

Similar to the overlapping battery problem, when the batteries are put in a metallic container or on a metallic plate, their positive(+)and negative(-)terminals may short-circuit through the conductive surface, depending on how the batteries are position.

**3. When The Battery is Held with Metallic Tweezers**

When held with a pair of metallic tweezers as shown, the battery short-circuits through the tweezers.

**4. When The Battery Lead Plates Touch Each Other**

When the battery lead plates bend and touch each other or other either terminal, the battery short-circuits.

**5. Solder Bridges**

Solder may bridge between circuit board conductors, causing a short-circuit and draining the battery.

**6. Short-circuits through Soldering Irons**

Similar to solder bridging, when the circuit board wiring is short-circuited by a soldering iron for an extended period the battery is drained and consumed. Complete short-circuits through soldering irons within 5 seconds.



#### 7. Short-circuits through Piled Circuit Boards

When circuit boards with the batteries are piled on top of one another, their conductive traces may touch and form a battery discharge circuit that consumes the battery's power.

#### 8. Discharge through Conductive Electrostatic Prevention Mats

Conductive mats are widely used to prevent static electricity from destroying semiconductors. If a circuit board with mounted battery is put on a conductive mat, the soldered conductors may touch the mat, providing a discharge path for the battery.

#### 9. Improper Battery Mounting Polarity

When the battery's positive (+) and negative (-) terminals are reversed with respect to the battery mounting's polarity marks, the battery may be discharged, depending on the type of electric circuit.

#### 10. Solder

When the battery lead plates are dipped in a molten solder bath, the battery is temporarily short-circuited. Therefore, complete dipping within 5 seconds.

### ■ Handling Precautions

Please read and observe the following precautions thoroughly.

Lithium Manganese Dioxide Battery contains flammable materials, such as organic solvent. Improper battery handling may cause leakage, heating, explosion or ignition of the battery, which may lead to injury or product failure.

### ■ PRECAUTIONS

1. Do not put the battery into microwave oven or drying machine.
2. Do not drop, apply excessive damage or deform the battery.
3. Do not mix the used battery together with the new battery or different type of batteries.
4. Do not store the battery in high temperature and high humidity location and where the battery is exposed to sunlight to avoid performance deterioration, swelling or leakage, of the battery.